

BASE AND TRANSPORT PLATE 30X60 M12

Code: 212116/0

Base plate 30x60 M12 for mounting hinged feet and wheels on aluminium profiles, providing flexible and stable support for various constructions.

[Link to the product →](#)

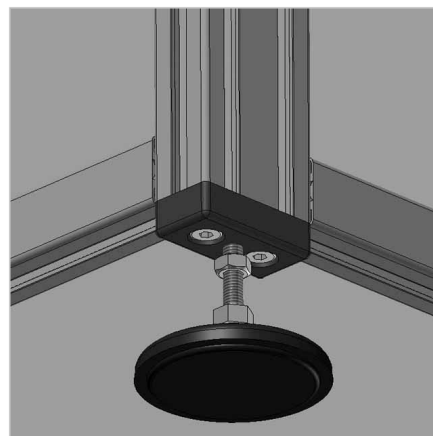
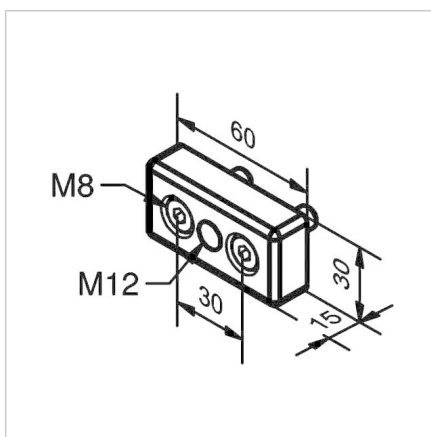

Technical data/items supplied

- Aluminium, Pressure die-casting, powder-coated, grey
- Fastening kit
- Weight = 0.080 kg/piece

Applications

- Fixing of hinged feet and castors
- Conductive variant **part no.** [21.2116/6/6/0](#)

Assembly

y

- Use fixing material supplied to fix to the end face of the profile