

## BASE AND TRANSPORT PLATE 45X90 M20

Code: 211047/0

Conductive base plate 45x90 M20 for mounting hinged feet and wheels on aluminium profiles, providing flexible and stable support for various constructions.

[Link to the product →](#)

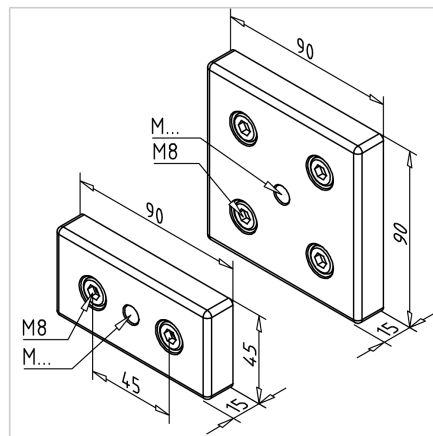
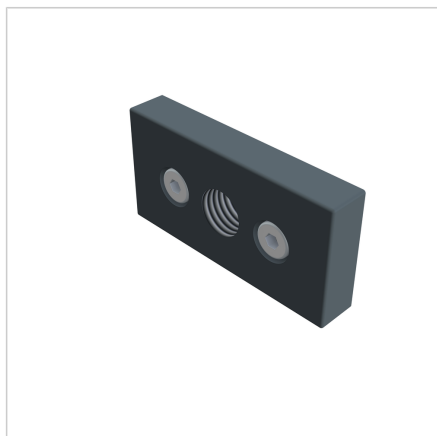

### Technical data/items supplied

- Aluminium, Pressure die-casting, powder-coated, grey
- Fastening kit
- Weight = 0.162 kg/piece

### Applications

- Centric attachment of hinged feet to profiles 45 x 90

### Assembly

- Use fixing material supplied to fix to the end face of the profile