

BASE AND TRANSPORT PLATE 90X32 M12

Code: 211358/0

Base plate 90x32 M12 for mounting hinged feet and wheels on aluminium profiles, providing flexible and stable support for various constructions.

[Link to the product →](#)

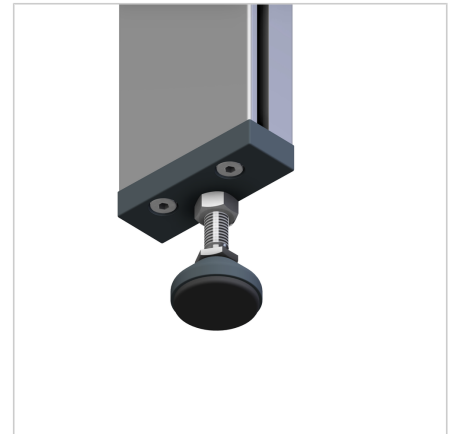
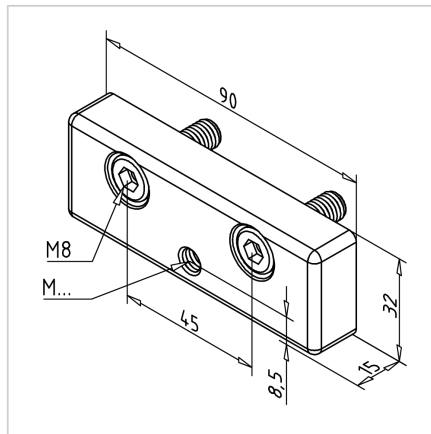

Technical data/items supplied

- Aluminium, Pressure die-casting, powder-coated, grey
- Fastening kit
- Weight = 0.125 kg/piece

Applications

- Fixing of feet on profiles 90 x 32 UL Art. no. [201066/0](#)

Assembly

- Use fixing material supplied to fix to the end face of the profile