

## DRIVING BELT A=250

Code: 211050/6

[Link to the product →](#)

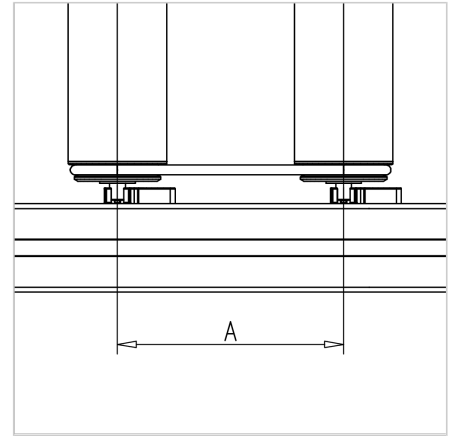
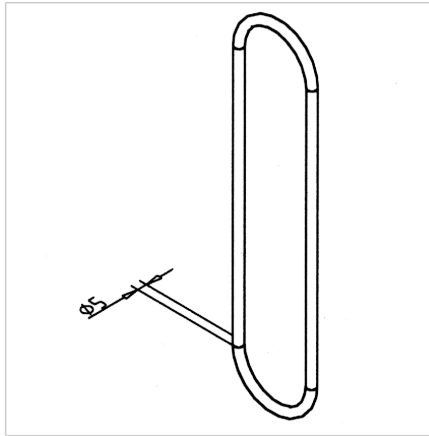

### Technical data/items supplied

- NBR, black
- Ø 5 mm
- Weight = 0.140 kg/piece

### Applications

- Drive the rollers with each other via the groove in the bearing sets. Preferably realize inaccessible places

### Assembly

- Insert the belt into the groove of the first roller and clip the roller into the bearing set
- Strap the belt over the second roller and, under tension, clip the roller into the bearing set