

END CAP 11X19 GREY

Code: 221030/1

Profile end cap 11 x 19. Plastic end cap for sealing and protecting aluminium profile edges. Easy installation and reliable protection.

[Link to the product →](#)

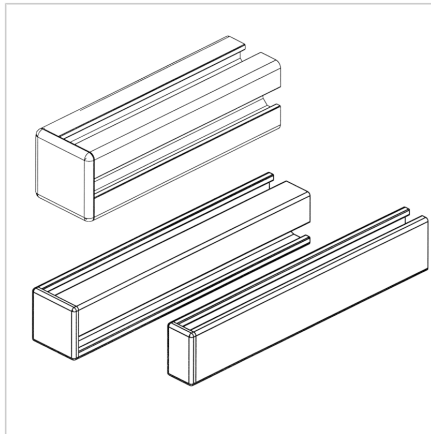

Technical data/items supplied

- ABS, Injection Mould, grey
- Weight = 0.001 kg/piece

Applications

- Mouth-side covering of profile ends of profile series 45