

## END CAP 23X16 Z GREY

Code: 220994/1

Profile end cap 23 x 16. Plastic end cap for sealing and protecting aluminium profile edges. Easy installation and reliable protection.

[Link to the product →](#)

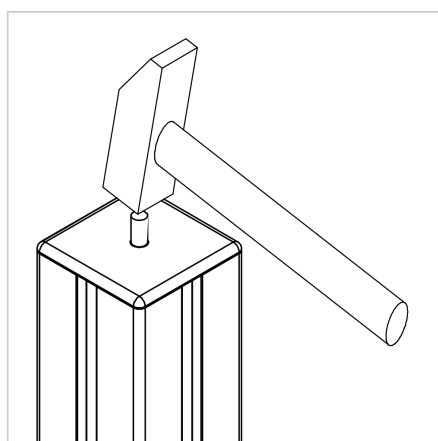
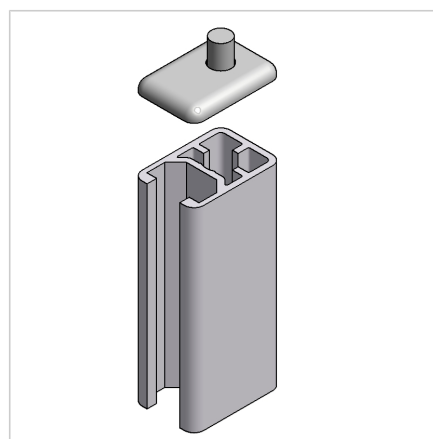
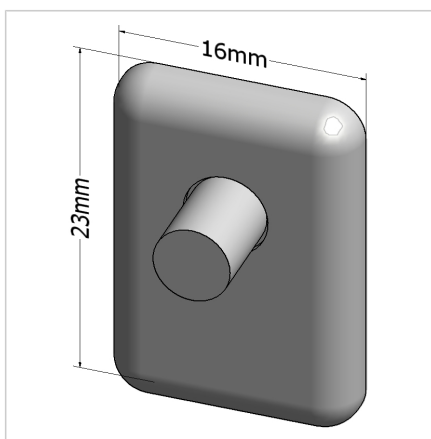

### Technical data/items supplied

- ABS, Injection Mould, grey
- Weight = 0.001 kg/piece

### Applications

- End face cover of series 30 profile ends

### Assembly

- Insert profile cap
- Use rubber hammer to drive in lock pin flush with the profile
- To dismantle, knock through the pin with a 4mm pin
- Spare pin set Part No. [221009/1](#) is required for reuse