

END CAP 45 R 60° ALU

Code: 221018/2

Profile end cap 45 R 60°. Aluminium end cap for sealing and protecting aluminium profile edges. Easy installation and reliable protection.

[Link to the product →](#)

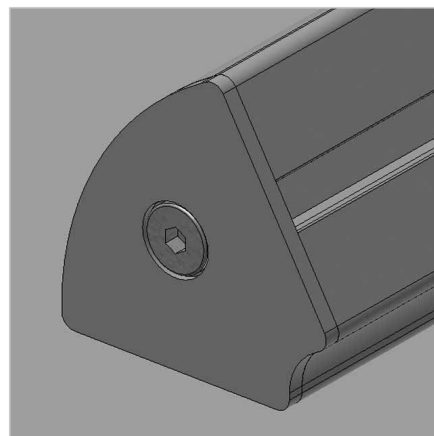
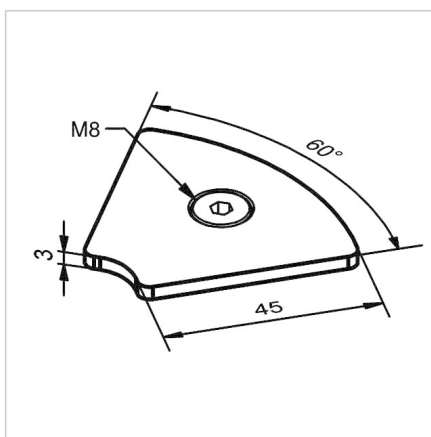
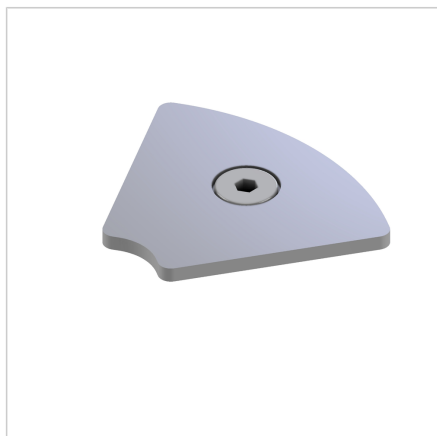

Technical data/items supplied

- Aluminium, anodized E6/EV1
- Supplied with pan head screws M8
- Weight = 0.054 kg/piece

Applications

- Mouth-side covering of profile ends of profile series 45
- Use at higher temperatures, chemically aggressive substances

Assembly

- Insert and screw on two thread M8 into the central hole in the end face of the profile