

## END CAP 45X135 Z GREY

Code: 221192/1

Profile end cap 45 x 135. Plastic end cap for sealing and protecting aluminium profile edges. Easy installation and reliable protection.

[Link to the product →](#)

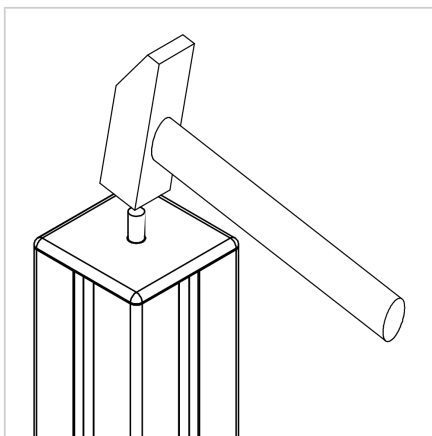

### Technical data/items supplied

- ABS, Injection Mould, grey
- Weight = 0.017 kg/piece

### Applications

- Mouth-side covering of profile ends of profile series 45

### Assembly

- Insert profile cap
- Use rubber hammer to drive in lock pin flush with the profile
- To dismantle, knock through the pin with a 4mm pin
- Spare pin set Part No. [221009/1](#) is required for reuse