

FASTENING KIT 90 S-A 90°

Code: 280173/0

Mounting kit 90 S-A 90° for linear guides with carriages ensures stable and efficient installation of axes in aluminium structures.

[Link to the product →](#)

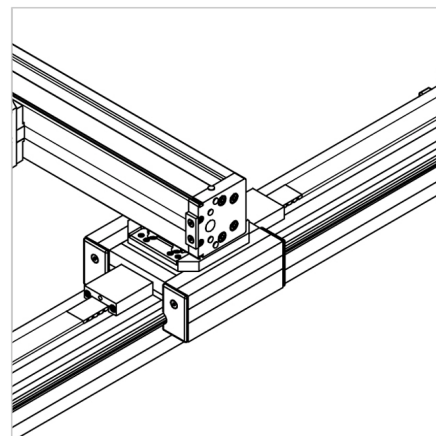
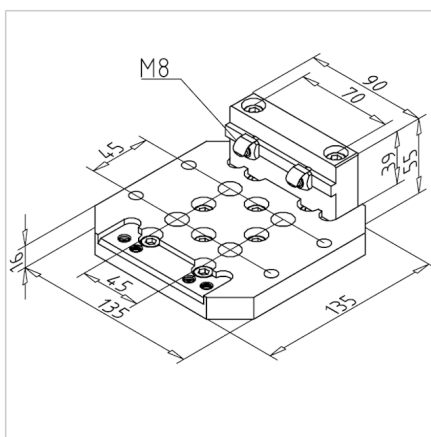
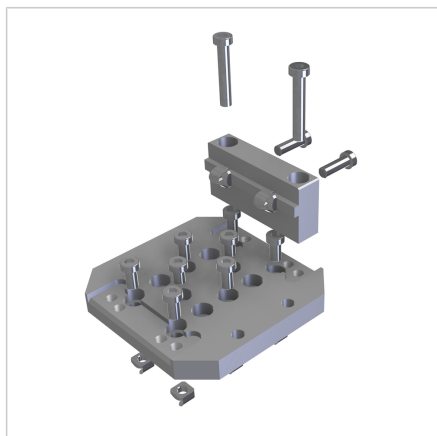

Technical data/items supplied

- Aluminium, anodized E6/EV1
- Adapter plate 90
- With fastening material steel, zinc plated
- Weight = 1.039 kg/piece

Applications

- For connection of 2 axes under 90°

Assembly

- Large plate is mounted on slide of:
 - LR6 or
 - LR6 compact or
 - LMS or- LMZ or
 - LR12 z.B. LW 45 / LW 90 or
 - slide of adjusting units
- No plate is mounted on: Carrier profile of the cross-sectional axis