

FOOT 30 COMPACT

Code: 212524/0

Compact adjustable foot for aluminium profiles series 30, providing stable and sleek mounting for smaller frame constructions in industrial applications

[Link to the product →](#)

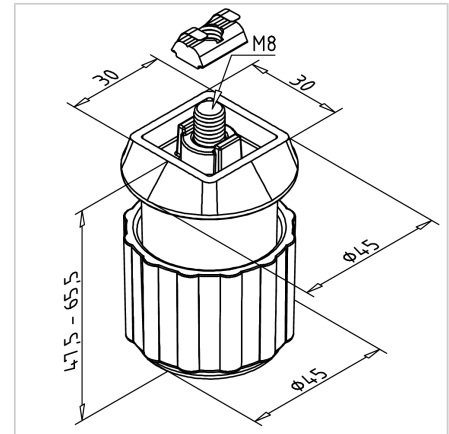
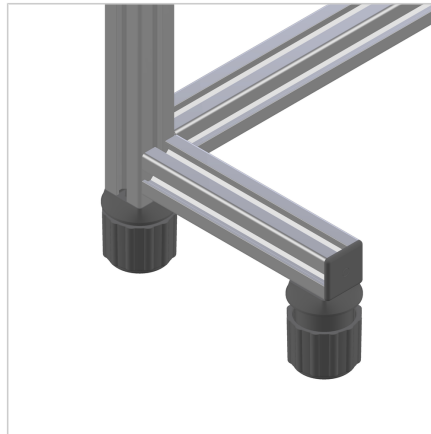

Technical data/items supplied

- PA, Injection Mould, grey
- With fastening material steel, zinc plated
- Max. load capacity: 100 Kg
- Adjustment area ± 9 mm
- With anti-skid rubber damper
- Weight = 0.121 kg/piece

Applications

- For installation and levelling of smaller frames with nice design

Assembly

- Assembly with to profile end or on profile face with delivered fixation material