

PNEUMATIC CONNECTION PLATE 45 G1/4"

Code: 241107/2

Pneumatic base plate 45 with G1/4" thread for easy mounting and connection of pneumatic components in profile systems.

[Link to the product →](#)

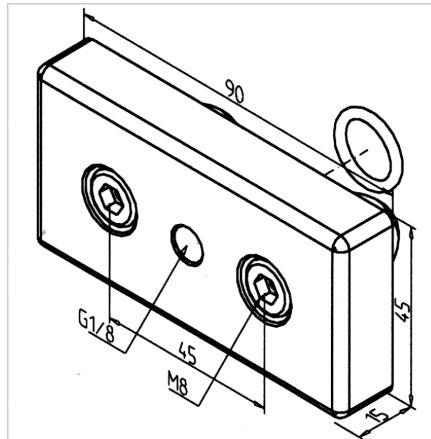

Technical data/items supplied

- Aluminium, Pressure die-casting, powder-coated, grey
- 1 x O-ring
- Fastening kit
- Weight = 0.170 kg/piece

Applications

- Side connection for compressed air supply or removal on profiles 45 x 90 and 90 x 90

Assembly

- Use industrial shock absorber supplied to mount in profile groove
- Drill bore \varnothing 12 mm in middle of profile