

## PNEUMATIC CONNECTION PLATE 45 G3/8"

Code: 241107/3

Pneumatic base plate 45 with G3/8" thread for easy mounting and connection of pneumatic components in profile systems.

[Link to the product →](#)

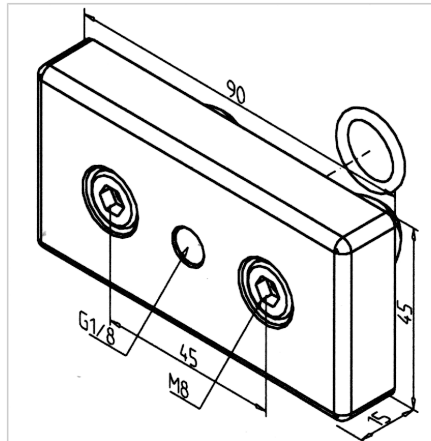
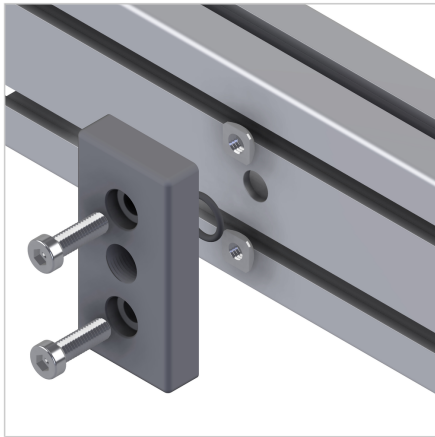

### Technical data/items supplied

- Aluminium, Pressure die-casting, powder-coated, grey
- 1 x O-ring
- Fastening kit
- Weight = 0.170 kg/piece

### Applications

- Side connection for compressed air supply or removal on profiles 45 x 90 and 90 x 90

### Assembly

- Use industrial shock absorber supplied to mount in profile groove
- Drill bore  $\varnothing$  12 mm in middle of profile