

## PNEUMATIC CONNECTION PLATE 90X90 G3/8"

Code: 241106/3

Pneumatic base plate 90x90 with G3/8" thread for easy mounting and connection of pneumatic components in profile systems.

[Link to the product →](#)

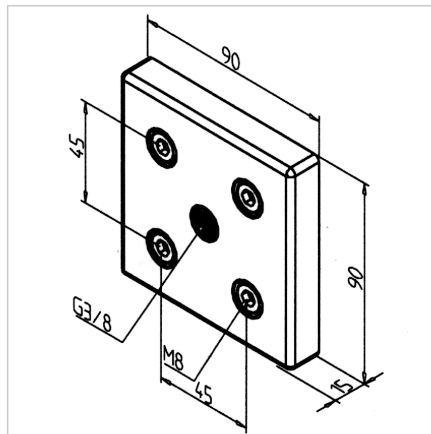
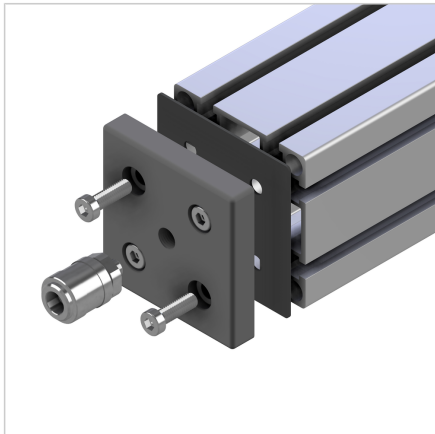

### Technical data/items supplied

- Aluminium, Pressure die-casting, powder-coated, grey
- With sealing plate of NBR, black
- Fastening kit
- Weight = 0.362 kg/piece

### Applications

- Closure of the hollow chamber ends of profiles 90 x 90 for connection of pneumatic connections

### Assembly

- Insert sealing plate
- Use fastening material included to screw into 4 central holes  $\varnothing$  7.5 mm (tightening torque 12 Nm)