

PROFILE 30 R 60°

Code: 201136/0

Alu profile 30 R 60° for industrial use. Explore our aluminium profile system – strong, modular, and easy to assemble.

[Link to the product →](#)

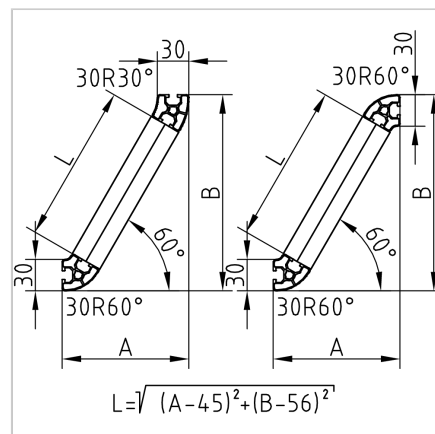
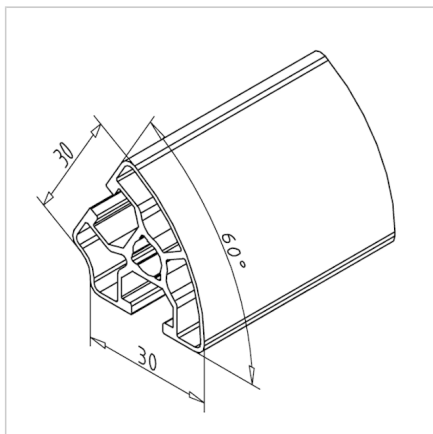

Technical data/items supplied

- Aluminium, extruded, anodized E6/EV1
- $I_x = 1.847 \text{ cm}^4$
- $I_y = 1.721 \text{ cm}^4$
- $w_x = 0.904 \text{ cm}^3$
- $w_y = 0.951 \text{ cm}^3$
- $IT = 3.568 \text{ cm}^4$
- Weight = 0.590 kg/m
- Bar length = 6 m
- Packing unit = 72 m

Applications

- Weight optimized constructions
- Tables
- Framework constructions
- Display windows, showcases
- As cross beam:
Calculate dimension L of the intermediate support according to calculating formular

Assembly

- Power-lock fastener 30 / N 30
- Mitre connector 30
- Screw connection 30
- Angle 16 / 30
- Attaching accessories with sliding nut 30
M4 / M5 / M6 / M8