

PROFILE 45 R 60°

Code: 201096/0

Alu profile 45 R 60° for industrial use. Explore our aluminium profile system – strong, modular, and easy to assemble.

[Link to the product →](#)

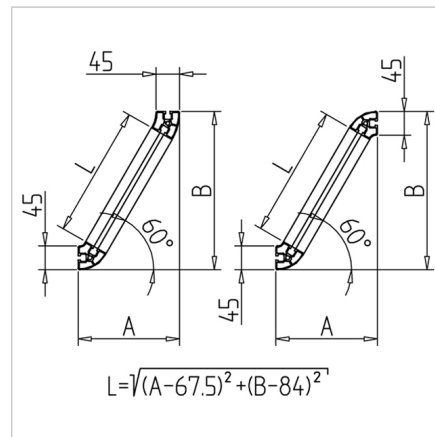
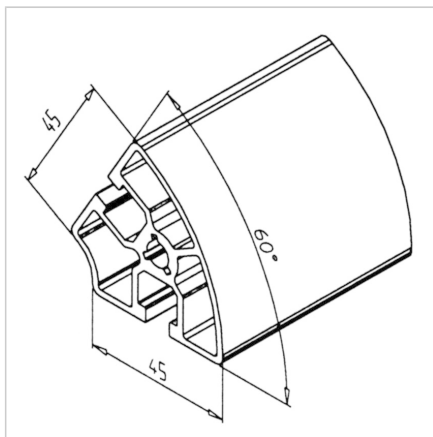

Technical data/items supplied

- Aluminium, extruded, anodized E6/EV1
- $I_x = 11.446 \text{ cm}^4$
- $I_y = 10.28 \text{ cm}^4$
- $w_x = 3.667 \text{ cm}^3$
- $w_y = 3.752 \text{ cm}^3$
- $IT = 21.560 \text{ cm}^4$
- Weight = 1.575 kg/m
- Bar length = 6 m
- Packing unit = 48 m

Applications

- Angled enclosures
- Tables
- Framework constructions
- Display windows, showcases
- As cross beam:
Calculate dimension L of the intermediate support according to calculating formular

Assembly

- MiniTec power-lock fastener
- Bolt connector