

PROFILE 45X135 1G

Code: 201078/0

Alu profile 45 x 135 1G for industrial use. Explore our aluminium profile system – strong, modular, and easy to assemble.

[Link to the product →](#)

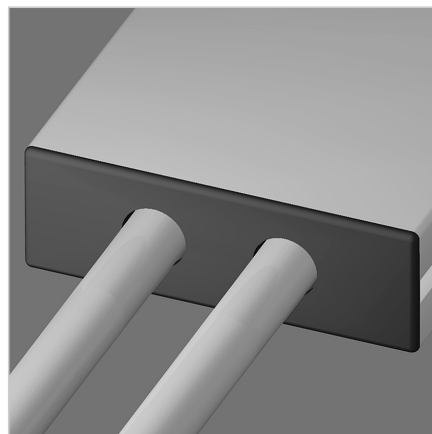
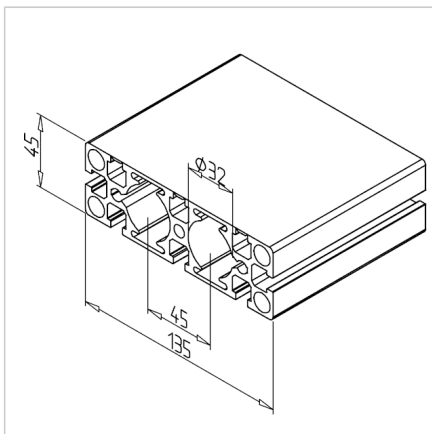

Technical data/items supplied

- Aluminium, extruded, anodized E6/EV1
- $I_x = 47.064 \text{ cm}^4$
- $I_y = 359.242 \text{ cm}^4$
- $w_x = 20.618 \text{ cm}^3$
- $w_y = 53.221 \text{ cm}^3$
- $IT = 189.739 \text{ cm}^4$
- Weight = 5.570 kg/m
- Bar length = 6 m
- Packing unit = 12 m

Applications

- All types of constructions, specifically for high hygiene requirements in the food industry, medical technology, bottling of beverages
- Linear guides LB as slide
- Central bore $\varnothing 32$ mm for ball-bushings LME 20, for ball-bearings 6201 or 6002, for compressed air piping or guiding of hydraulic add-in cylinders

Assembly

- MiniTec power-lock fastener
- Closed grooves can be opened with the groove opener **part no. 260815/0** to the desired length