

## SCREW BLOCK 30

Code: 221250/0

[Link to the product →](#)

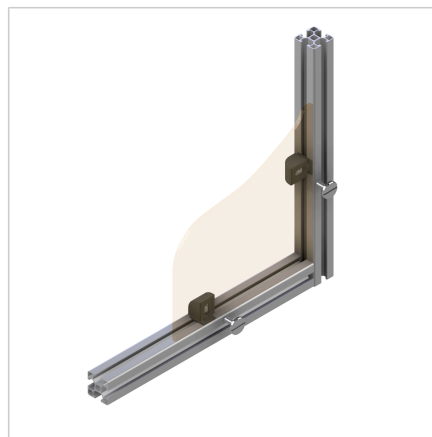
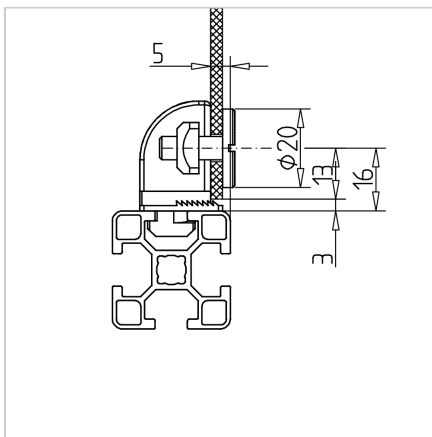
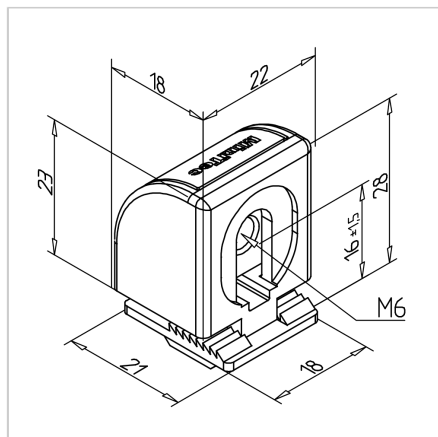

### Technical data/items supplied

- ABS, Injection Mould, grey
- Nut M6, steel, zinc-plated
- Also available with thread dimensions M4/M5
- Weight = 0.011 kg/piece

### Applications

- Suitable for all profiles of series 30
- Retrofitting surface elements 2 mm to 6 mm thickness
- Circulating air gap 7 mm

### Assembly

- Insert socket into profile groove
- Insert bored surface elements
- Screw down the surface elements
- Recommended flat head screw M6x12  
**part no. 212074/0** up to 3 mm disc thickness or M6x16 **part no. 211246/0** for greater strengths