

SLIDE LWG 32X45-90 WITH OUT CLAMPING DEVICE

Code: 280133/0

Linear carriage LWG 32 x 45 series 90 ensures precise and smooth linear motion in aluminum profile constructions.

[Link to the product →](#)

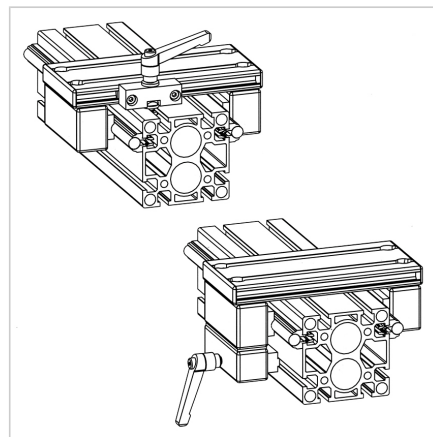
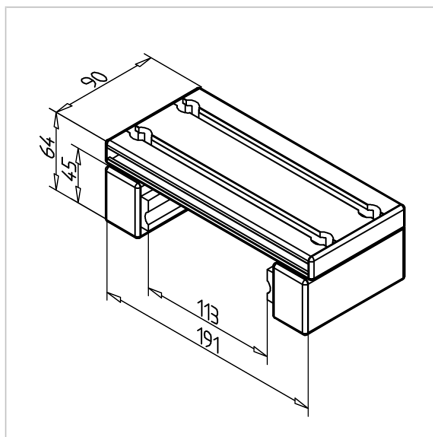
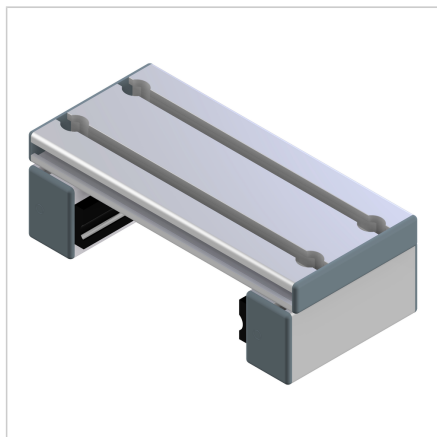

Technical data/items supplied

- Aluminium, anodized E6/EV1
- Fully mounted carriage
- 2 slide rails LG
- End caps
- Load capacity up to 450 N
- Clearance adjusted
- Weight = 0.810 kg/piece

Applications

- Simple linear guides
- Slide units
- For rail 90 with shafts \varnothing 12 mm

Other versions

- With slide clamping at top **part no.** [280133/1](#)
- With slide clamping lateral **part no.** [280133/2](#)
- Different slide lengths