

SQUARE-NUT 30 M05 WITH POSITION-FIXING

Code: 212341/2

Square nut 30 M5 Z with position-fixing. Designed for precise and reliable fastening in ESD-sensitive aluminium profile constructions.

[Link to the product →](#)

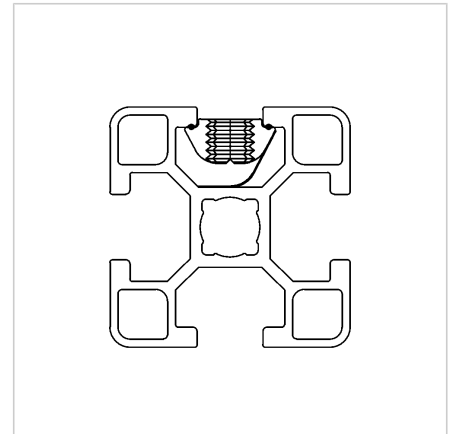
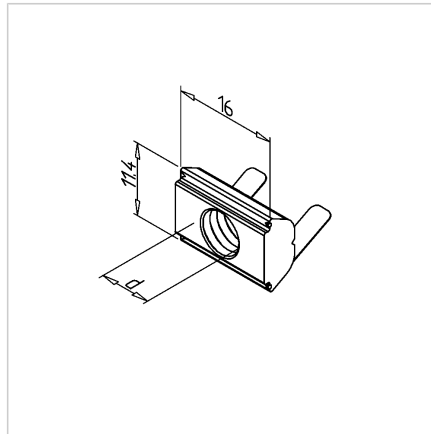

Technical data/items supplied

- Steel, galvanized
- Thread (d) : M 5
- Conductive, also suitable for ESD applications
- Weight = 0.005 kg/piece

Applications

- The spring plate holds the nut in the desired position
- Sliding nuts can be swiveled into the profile (series 45) at any point

Assembly

- Mounting by swiveling into the groove