

## SQUARE-NUT M5 H WITH POSITION FIXING

Code: 211320/4

Square nut M5 H with position fixing for precise and secure fastening in aluminium profile systems. Prevents rotation for stable and reliable assemblies.

[Link to the product →](#)

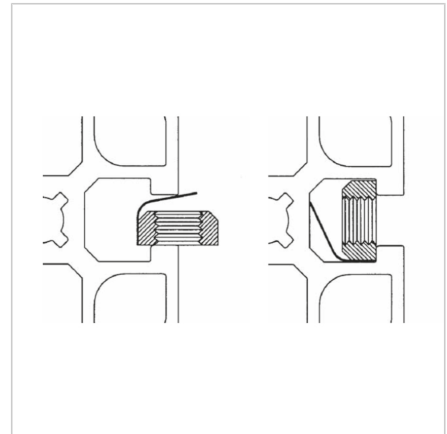
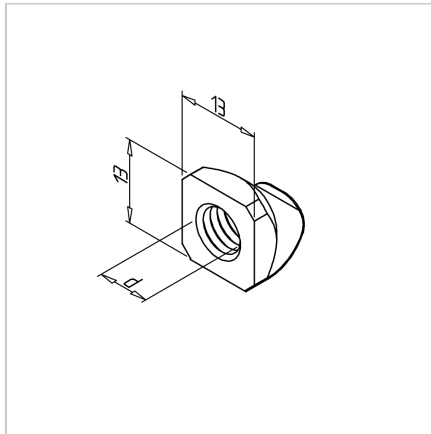
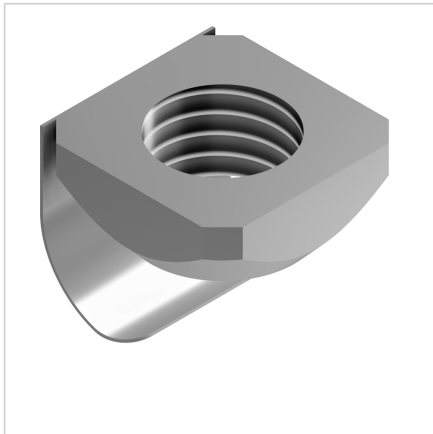

### Technical data/items supplied

- Stainless steel
- Thread (d) : M 5
- Weight = 0.005 kg/piece

### Applications

- Sliding nuts can be swiveled into the profile (series 45) at any point
- The spring plate holds the nut in the desired position

### Assembly

- Mounting by swiveling into the groove