

## SQUARE WASHER 8

Code: 211360/0

Square washer 8 for even force distribution when fastening aluminium profiles. Ensures stable connections and protects surface areas.

[Link to the product →](#)

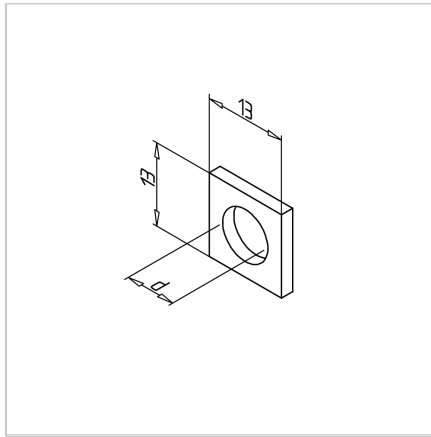
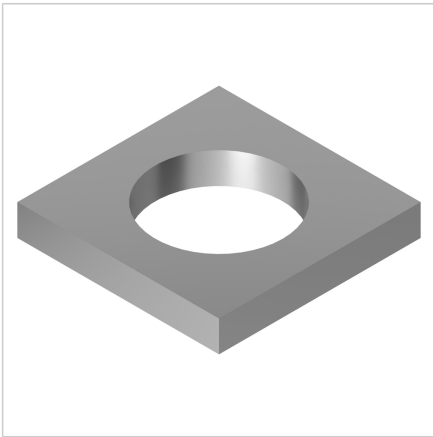

### Technical data/items supplied

- Steel, galvanized
- Diameter (d) : 8.5 mm
- Weight = 0.002 kg/piece