

## TIMING BELT PULLEY LR 6\_10 STAINLESS FEATHER KEY 3 MM

Code: 280509/1

Timing belt end piece LR 6\_10 stainless for precise and reliable motion transmission in linear guides.

[Link to the product →](#)

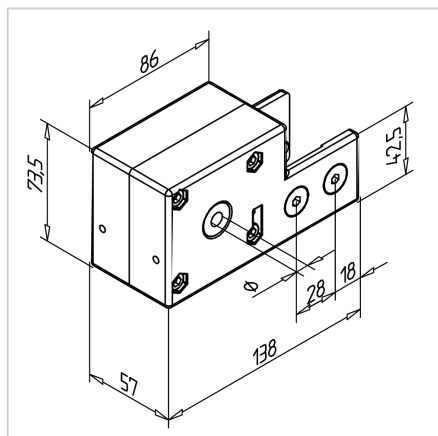

### Technical data/items supplied

- Aluminium, Pressure die-casting, powder-coated, grey
- Connecting elements in stainless steel
- Aluminium pulley with flanges made of stainless steel for timing belt 16AT5 36 teeth, effective diameter 57.3 mm  
Timing belt length required within the return/reversing point 160 mm max. Torque 30 Nm
- Pulley with bore 10 mm and feather key groove 3 mm
- 2 ball-bearings
- Weight = 0.960 kg/piece

### Applications

- For MiniTec linear guides LR 6 Z

### Assembly

- Insert square nut M8 in rail and pre-position
- Guide the timing belt through the reverse unit
- Guide the pulley on rail end
- Pre-assemble fastening screws
- Fix timing belt on slide
- Tighten at pulley using hex Allen key SW3
- Tighten fastening screws